

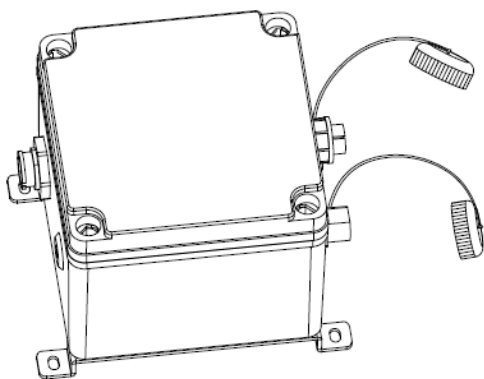

# Blue Plug & Play Motion Sensor



## FUNKTION

### 1. Av/på-funktion (standby-period: 0 s)

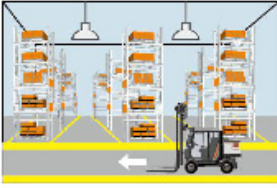

Vid tillräckligt stark omgivningsbelysningen tänds inte belysningen, även om rörelse



Vid otillräcklig omgivningsbelysningen tänds sensorn belysningen när rörelse detekteras.



När hålltiden har löpt ut släcker sensorn belysningen (om ingen rörelse detekteras).

### 2. 2-steps dimningsfunktion (standby-period ”+∞”)

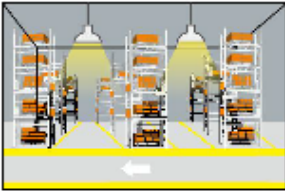

När ingen rörelse detekteras förblir belysningen svag.

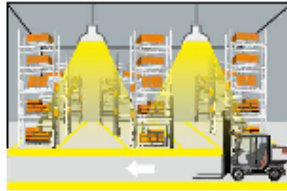

När rörelse detekteras tänds sensorn belysningen med full ljusstyrka.

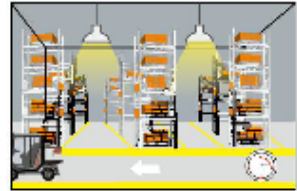

När hålltiden har löpt ut dimmar sensorn belysningen till aktuell låg ljusstyrka (om ingen rörelse detekteras).

### 3. 3-steps dimningsfunktion (standby-period, 5 s, 5 min, 10 min, 30 min, 1 tim)

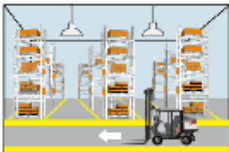

Vid tillräckligt stark omgivningsbelysningen tänds inte belysningen, även om rörelse detekteras.



Vid otillräcklig omgivningsbelysningen tänds sensorn belysningen när rörelse detekteras.

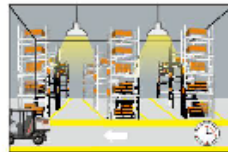

När hålltiden har löpt ut dimmar sensorn belysningen till låg ljusstyrka (om ingen ny rörelse detekteras).

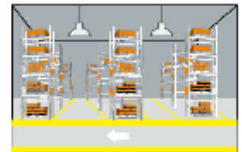

När standby-perioden har löpt ut släcker sensorn belysningen (om ingen rörelse detekteras i den övervakade zonen).

## TEKNISKA DATA

<b>Beskrivning</b>	<b>Blue Plug &amp; Play Rörelsesensor</b>
Artikelnummer	EB15564
Hålltid	5 s, 30 s, 90 s, 3 min, 20 min, +∞
Standby-nivå för dimming	10, 20, 30, 50 %
Standby-period	0 s, 5 s, 5 min, 10 min, 30 min, 1 tim, +∞
Detekteringsområde	10, 50, 75, 100 %
Dagsljussensor (lux)	2, 5, 10, 25, 50, och 100 samt inaktiverad
Installationshöjd	Rekommendation: 3–10 meter (max. 12 meter).
Detekteringsvinkel	150° (vägginstallation), 360° (takinstallation)

## KONSTRUKTION

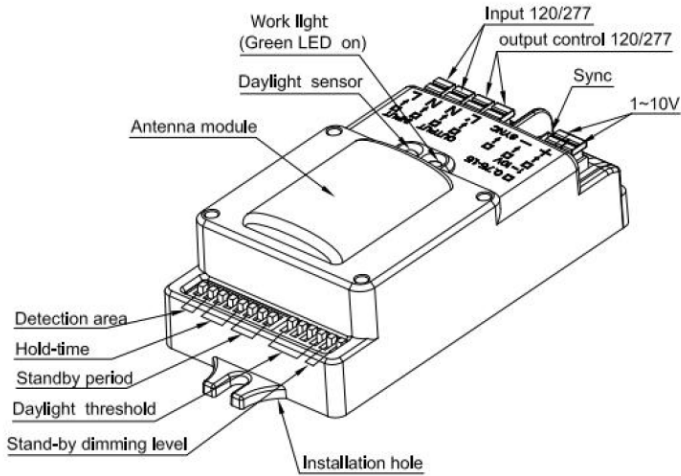

## DETEKTERINGSMÖNSTER

### Takinställation

Höjd: 3m  
Känslighet: 100%

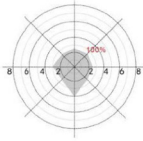

Höjd: 6m  
Känslighet: 100%

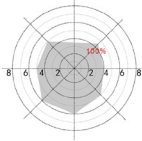

Höjd: 9m  
Känslighet: 100%/75%

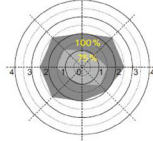

Höjd: 12m  
Känslighet: 100%

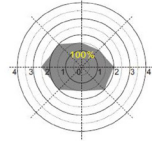

Snabb rörelse  
(Hastighet: 1 m/s)

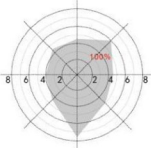

Snabb rörelse  
(Hastighet: 1 m/s)

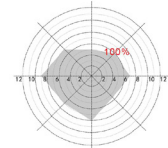

Snabb rörelse  
(Hastighet: 1 m/s)

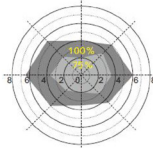

Snabb rörelse  
Hastighet: 1 m/s

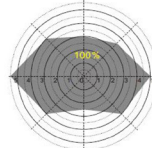

Långsam rörelse  
(Hastighet: 0,3 m/s)



Långsam rörelse  
(Hastighet: 0,3 m/s)



Långsam rörelse  
(Hastighet: 0,3 m/s)



Långsam rörelse  
Hastighet: 0,3 m/s

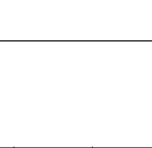

## INSTÄLLNINGAR FÖR DIP-OMKOPPLARE

### Detekteringsområde

ON ↑ 		1	2	
	I	ON	ON	100%
	II	ON	-	75%
	III	-	ON	50%
	IV	-	-	10%

### Hålltid

ON ↑ 		3	4	5	
	I	ON	ON	ON	5S
	II	-	ON	ON	30s
	III	ON	-	ON	90S
	IV	-	-	ON	3min
	V	ON	ON	-	20min
	VI	-	-	-	+∞

Standby-period:

		6	7	8	
	I	ON	ON	ON	0S
	II	-	ON	ON	5S
	III	ON	-	ON	5min
	IV	-	-	ON	10min
	V	ON	ON	-	30min
	VI	-	ON	-	1H
	VII	-	-	-	+∞

Dagsljussensor

		1	2	3	4	
	I	-	-	ON	ON	2Lux
	II	-	-	-	ON	5Lux
	III	-	ON	ON	-	10Lux
	IV	-	-	ON	-	25lux
	V	-	ON	-	-	50lux
	VI	ON	-	-	-	100lux
	VII	-	-	-	-	Disable

Standby-nivå för dimning

		5	6	Brightness%
	I	ON	ON	50%
	II	-	ON	30%
	III	ON	-	20%
	IV	-	-	10%

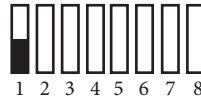

DIP-omkopplarens  
läge (-) mot siffran



DIP-omkopplarens läge  
(PÅ) bort från siffran

## SERIEKOPPLING

Sensorerna är möjliga att seriekopplas för att öka detektionsområdet.

1. Flyttas den röda ledaren från (DIM +) till (SYNC) på båda de seriekopplade sensorerna.
2. Koppla en förlängningskabel med M16 koppling mellan de seriekopplade sensorerna.
3. Montera den medföljande M16 kopplingen på förlängningskabeln så att kontakterna monteras ihop.

## DAGSLJUSSENSOR

Dagsljussensorn stänger av rörelsedetektering vid dagsljus. Vid kontinuerlig rörelse aktiveras dagsljussensorn först efter rörelserna upphört. Dagsljussensorn går att ställa efter önskad ljusnivå.

## FABRIKSINSTÄLLNING

Detekteringsområde: 100 %, hålltid: 5 s, standby-period: 5 s, standby-nivå för dimning: 10 %, dagsljussensor: inaktiverad

## ANVÄNDNINGSOMRÅDE

Denna sensor är främst avsedd för användning i sluten miljö. Om den används utomhus måste detekteringsområdet övervakas noggrant, eftersom vind, regn och rörliga föremål kan orsaka falsk utlösning. Försäkra dig om att det inte förekommer rörliga föremål runt omkring sensorn, som till exempel fläkt, likströmsmotor, avloppsrör, luftutlopp etc. (dessa kan orsaka falsk utlösning av sensorn).

## FUNKSJON

### 1. På-av-funksjon (standby-periode "0 sek")

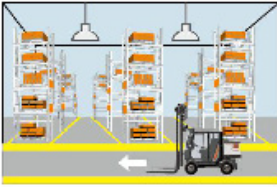

Når det er nok dagslys, slår ikke lyset seg på selv om det finnes bevegelsessignaler.



Når det er for lite dagslys, slår sensoren på lyset når bevegelse detekteres.

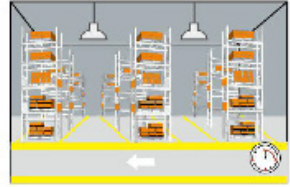

Etter utløpt holdetid slår sensoren av lyset når det ikke detekteres bevegelse.

### 2. 2-trinns dimmefunksjon (standby-periode "+∞")



Hvis det ikke detekteres bevegelse, forblir lyset på lavt nivå hele tiden.

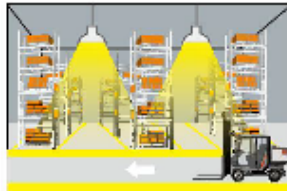

Når bevegelse detekteres, slår sensoren på lyset med 100 % lysstyrke.

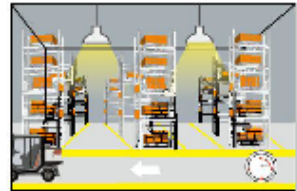

Etter utløpt holdetid dimmer sensoren lyset til lavt nivå hvis det ikke detekteres bevegelse.

### 3. 3-trinns dimmefunksjon (standby-periode "5 sek / 5 min / 10 min / 30 min / 1 t")

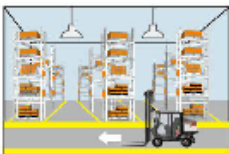

Når det er nok dagslys, slår ikke lyset seg på selv om det finnes bevegelsessignaler.



Når det er for lite dagslys, slår sensoren på lyset når bevegelse detekteres.



Etter utløpt holdetid dimmer sensoren lyset til lavt nivå hvis det ikke detekteres ny bevegelse.

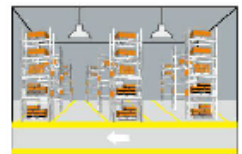

Etter utløpt standby-periode slår sensoren av lyset hvis det ikke detekteres bevegelse i deteksjonsområdet.

## TEKNISKE DATA

<b>Beskrivelse:</b>	<b>Blue Plug &amp; Play Bevegelsessensor</b>
Artikkelnummer:	EB15564
Holdetid:	5 sek / 30 sek / 90 sek / 3 min / 20 min / +∞
Standby-dimmenivå:	10 % / 20 % / 30 % / 50 %
Standby-periode:	0 sek / 5 sek / 5 min / 10 min / 30 min / 1 t / +∞
Deteksjonsområde:	10 % / 50 % / 75 % / 100 %
Dagslyssensor:	2 lux / 5 lux / 10 lux 25 lux / 50 lux / 100 lux / Deaktivert
Monteringshøyde:	Forslag: 3–10 m, støtter maks. 12 m
Deteksjonsvinkel:	150° (veggmontering) 360° (takmontering)

## UTFORMING

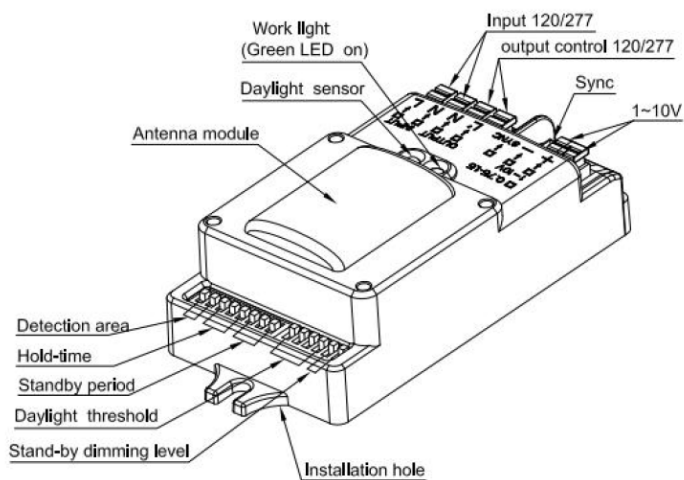

## DETEKSJONSMØNSTER

### Takmontering

Høyde: 3m

Følsomhet: 100%

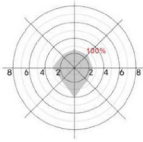

Høyde: 6m

Følsomhet: 100%

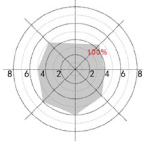

Høyde: 9m

Følsomhet: 100%/75%

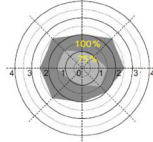

Høyde: 12m

Følsomhet: 100%

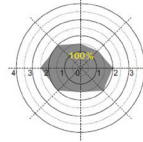

Rask bevegelse

(Hastighet: 1 m/s)

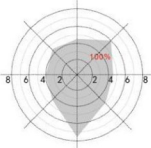

Rask bevegelse

(Hastighet: 1 m/s)

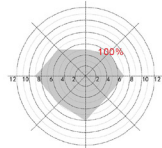

Rask bevegelse

(Hastighet: 1 m/s)

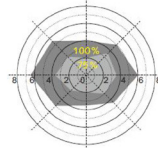

Rask bevegelse

(Hastighet: 1 m/s)

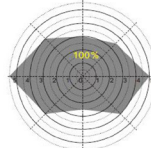

Langsom bevegelse

(Hastighet: 0,3 m/s)



Langsom bevegelse

(Hastighet: 0,3 m/s)

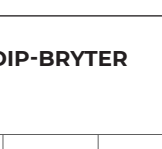

Langsom bevegelse

(Hastighet: 0,3 m/s)

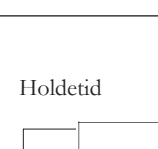

Langsom bevegelse

(Hastighet: 0,3 m/s)

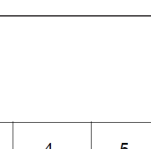

## INNSTILLINGER FOR DIP-BRYTER

Deteksjonsområde

		1	2	
	I	ON	ON	100%
	II	ON	-	75%
	III	-	ON	50%
	IV	-	-	10%

Holdetid

		3	4	5	
	I	ON	ON	ON	5S
	II	-	ON	ON	30s
	III	ON	-	ON	90S
	IV	-	-	ON	3min
	V	ON	ON	-	20min
	VI	-	-	-	+∞



## Standby-periode

		6	7	8	
	I	ON	ON	ON	0S
	II	-	ON	ON	5S
	III	ON	-	ON	5min
	IV	-	-	ON	10min
	V	ON	ON	-	30min
	VI	-	ON	-	1H
	VII	-	-	-	+∞

## Dagslyssensor

		1	2	3	4	
	I	-	-	ON	ON	2Lux
	II	-	-	-	ON	5Lux
	III	-	ON	ON	-	10Lux
	IV	-	-	ON	-	25lux
	V	-	ON	-	-	50lux
	VI	ON	-	-	-	100lux
	VII	-	-	-	-	Disable

## Standby-dimmenivå

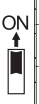
		5	6	Brightness%
	I	ON	ON	50%
	II	-	ON	30%
	III	ON	-	20%
	IV	-	-	10%

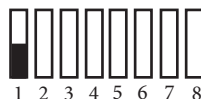

DIP-bryter (-) posisjon mot nummer



DIP-bryter (PÅ) posisjon bort fra nummer

## SERIEKOBLING

Sensorene kan seriekobles for å øke deteksjonsområdet.

1. Flytt den røde lederen fra (DIM +) til (SYNC) på begge de seriekoblede sensorene.
2. Koble en forlengelseskabel med M16-kobling mellom de seriekoblede sensorene.
3. Monter den medfølgende M16-koblingen på forlengelseskabelen slik at kontaktene monteres sammen

## DAGSLYSSENSOR

Dagslyssensoren slår av bevegelsesdeteksjonen ved dagslys. Ved kontinuerlig bevegelse aktiveres dagslyssensoren først etter at bevegelsene har opphørt. Dagslyssensoren kan stilles inn etter ønsket lysnivå.

## FABRIKKINNSTILLING

Deteksjonsområde: 100 %, Holdetid: 5 sek, Standby-periode: 5 sek, Standby-dimmenivå: 10 %, Dagslyssensor: Deaktivert

## BRUK

Denne sensoren er hovedsakelig beregnet på bruk i et lukket miljø. Vind, regn og bevegelige gjenstander utendørs kan føre til falsk utløsning av sensoren. Deteksjonsområdet må kontrolleres nøye. Vennligst sørg for at det ikke finnes bevegessignaler rundt sensoren, f.eks. vifte, DC-motor, avløpsrør, luftutløp osv. Det kan nemlig føre til falsk utløsning av sensoren.

## TOIMINTA

### 1. On-off-toiminto (valmiusaika ”0 s”)

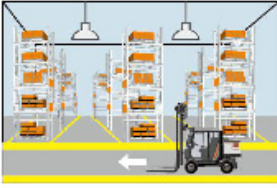

Kun ympäristövalo on riittävä valoa ei sytytetä liikesignaalilakeaan.



Kun ympäristövaloa on liian vähän, tunnistin sytyttää valon, kun liikettä havaitaan.



Pitoajan jälkeen tunnistin sammuttaa valon, kun liikettä ei havaita.

### 2. 2-portainen himmennystoiminto (valmiusaika ”+∞”)

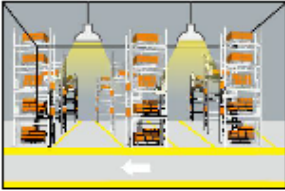

Jos liikettä ei havaita, valo jää palamaan himmeämmällä valolla.

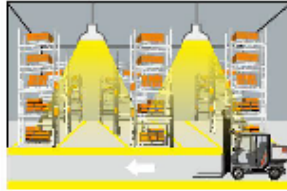

Kun liike havaitaan, tunnistin kytkee valon 100 %:n kirkkautteen.

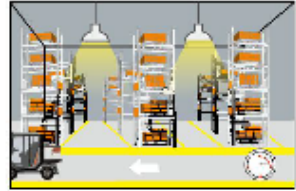

Pitoajan jälkeen tunnistin himmentää valon vallitsevalle alhaiselle tasolle, jos liikettä ei havaita.

### 3. 3-portainen himmennystoiminto (valmiusaika ”5 s/5 min/10 min/30 min/1 h”)

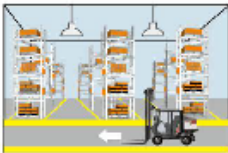

Kun ympäristövalo on riittävä valoa ei sytytetä liikesignaalilakeaan.



Kun ympäristövaloa on liian vähän, tunnistin sytyttää valon, kun liikettä havaitaan.

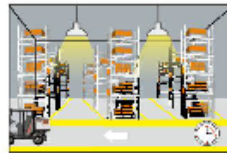

Pitoajan jälkeen tunnistin himmentää valon alhaiselle tasolle, jos uutta liikettä ei havaita.

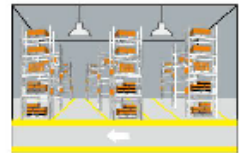

Valmiusaikan jälkeen tunnistin sammuttaa valon, jos tunnistusalueella ei havaita liikettä.

## TEKNISET TIEDOT

<b>Kuvaus:</b>	<b>Blue Plug &amp; Play -Liiketunnistin</b>
Tuotenumero:	EB15564
Pitoaika:	5 s/30 s/90 s/3 min/20 min/+∞
Valmiustilan himmennystaso:	10 %/20 %/30 %/50 %
Valmiusaika:	0 s/5 s/5 min/10 min/30 min/1 h/+∞
Tunnistusalue:	10 %/50%/75%/100%
Päivänvaloanturi:	2 lux/5 lux /10 lux 25 lux /50 lux /100 lux /Pois
Asennuskorkeus:	Suositus: 3–10 m tuki 12 m Maks.
Tunnistuskulma:	150°(seinäasennus) 360°(kattoasennus)

## RAKENNE

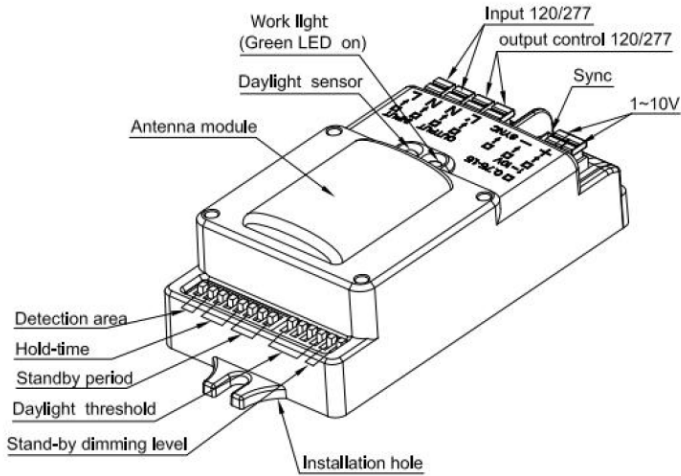

## TUNNISTUSKUVIO

### Kattoasennus

Korkeus: 3m

Herkkyys: 100%

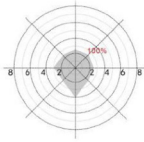

Korkeus: 6m

Herkkyys: 100%

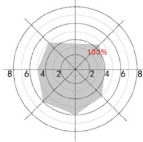

Korkeus: 9m

Herkkyys: 100%/75%

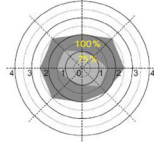

Korkeus: 12m

Herkkyys: 100%

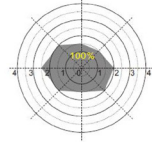

Nopea liike

(Nopeus: 1 m/s)

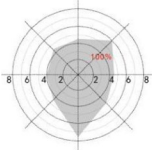

Nopea liike

(Nopeus: 1 m/s)

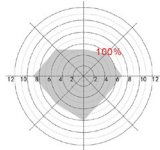

Nopea liike

(Nopeus: 1 m/s)

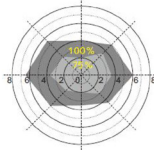

Nopea liike

(Nopeus: 1 m/s)

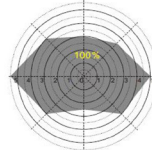

Hidas liike

(Nopeus: 0,3 m/s)



Hidas liike

(Nopeus: 0,3 m/s)

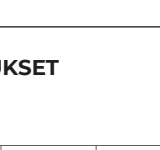

Hidas liike

(Nopeus: 0,3 m/s)



Hidas liike

(Nopeus: 0,3 m/s)

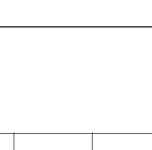

## DIP-KYTKIMEN ASETUKSET

### Tunnistusalue

		1	2	
	I	ON	ON	100%
	II	ON	-	75%
	III	-	ON	50%
	IV	-	-	10%

### Pitoaika

		3	4	5	
	I	ON	ON	ON	5S
	II	-	ON	ON	30s
	III	ON	-	ON	90S
	IV	-	-	ON	3min
	V	ON	ON	-	20min
	VI	-	-	-	+∞

## Valmiusaika

		6	7	8	
I	ON	ON	ON	0S	
II	-	ON	ON	5S	
III	ON	-	ON	5min	
IV	-	-	ON	10min	
V	ON	ON	-	30min	
VI	-	ON	-	1H	
VII	-	-	-	+∞	

## Päivänvaloanturi

		1	2	3	4	
I	-	-	ON	ON		2Lux
II	-	-	-	ON		5Lux
III	-	ON	ON	-		10Lux
IV	-	-	ON	-		25lux
V	-	ON	-	-		50lux
VI	ON	-	-	-		100lux
VII	-	-	-	-		Disable

## Valmiustilan himmennystaso

		5	6	Brightness%
I	ON	ON		50%
II	-	ON		30%
III	ON	-		20%
IV	-	-		10%



DIP-kytkimen (-)  
asennot kohti nu-

DIP-kytkimen (PÄÄLLÄ)  
asennot numerosta pois päin

## SARJAKYTKENTÄ

Tunnistimet voidaan kytkeä sarjaan tunnistusalueen suurentamiseksi

1. Siirrä punainen johdin liitännästä (DIM +) liitääntään (SYNC) kummassakin sarjaankytketyssä tunnistimessa.
2. Kytke M16-liittimellä varustettu jatkoakaapeli sarjaankytkettyjen tunnistimien välille.
3. Asenna toimitettu M16-liitin jatkoakaapeliin niin, että koskettimet voidaan liittää.

## PÄIVÄNVALOANTURI

Dagsljussensorn stänger av rörelsedetektering vid dagsljus. Vid kontinuerlig rörelse aktiveras dagsljussensorn först efter rörelserna upphört. Dagsljussensorn går att ställa efter önskad ljusnivå.

## TEHDASASETUS

Päivänvaloanturi kytkee liiketunnistuksen pois päältä päivänvalossa. Kun liike on jatkuva, päivänvaloanturi aktivoituu vasta liikkeen lakattua. Päivänvaloanturin valotasoa voidaan säätää halutuksi.

## KÄYTTÖ

Tämä anturi on tarkoitettu käytettäväksi pääasiassa suljetussa ympäristössä. Tuuli, sade ja liikkuvat ulko-kohteet voivat aiheuttaa vääriä laukaisuja, tunnistusalueetta on seurattava tarkasti.

Varmista, että anturin ympärillä ei ole liikkuvia signaaleja, kuten tulleitin, tasavirtamoottori, viemäriputki, ilman poistoaukko jne., Anturi saattaa aiheuttaa väärän laukaisun.

## FUNCTION

### 1. On-off function (Stand-by Period “0s”)

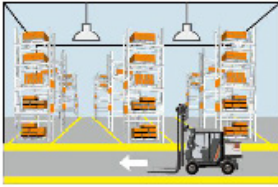

With sufficient ambient light, the light will not be switched on even if with motion signal.



With insufficient ambient light, the sensor switches on the light when motion is detected.

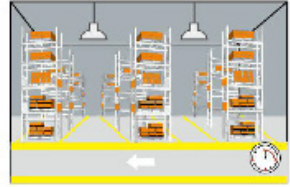

After elapse of hold time, the sensor switches off the light when no motion is detected.

### 2. 2-step dimming function (Stand-by Period “+∞”)

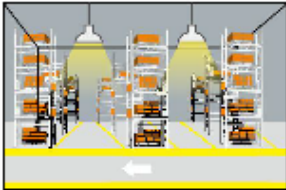

If there is no motion detected, the light will be remained at a low light level at the time.

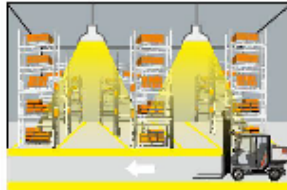

When motion is detected, the sensor will switch on the light to 100% brightness.

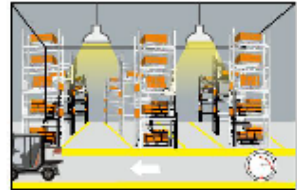

After elapse of hold time, the sensor dims the light at the present low light level if no motion is detected.

### 3. 3-step dimming function (Stand-by Period “5s/5min/10min/30min/1h”)

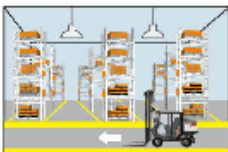

With sufficient ambient light, the light will not be switched on even if with motion signal.



With insufficient ambient light, the sensor switches on the light when motion is detected.

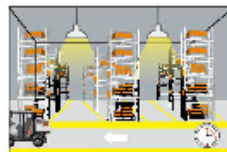

After elapse of hold time, the sensor dims the light at a low light level if no new motion is detected.

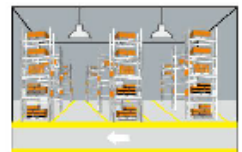

After elapse of standby period, the sensor switches off the light if no motion is detected in the detected zone.

## TECHNICAL DATA

<b>Beskrivning:</b>	<b>Blue Plug &amp; Play Motion Sensor</b>
Artikelnummer:	EB15564
Hold time:	5s/30s/90s/3min/20min/+∞
Stand-by dim Level:	10%/20%/30%/50%
Stand-by Period:	0S/5S/5min/10min/30min/1h/+∞
Detection Area:	10%/50%/75%/100%
Daylight sensor:	2 lux/5Lux /10Lux 25Lux /50Lux /100Lux /Disable
Mounting height:	Suggest: 3-10m support 12m Max.
Detecting angle:	150°(wall mounting) 360°(ceiling mounting)

## STRUCTURE

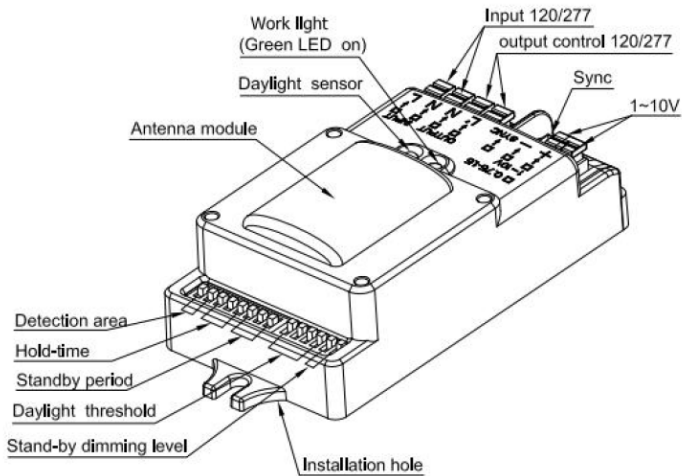

## DETECTION PATTERN

### Ceiling mounting

Height: 3m

Sensitivity: 100%

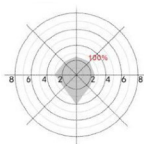

Height: 6m

Sensitivity: 100%

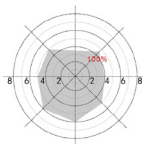

Height: 9m

Sensitivity: 100%/75%

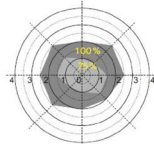

Height: 12m

Sensitivity: 100%

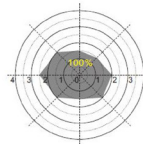

Rapid movement  
(Speed: 1 m/s)

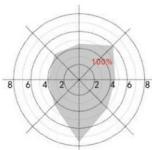

Rapid movement  
(Speed : 1 m/s)

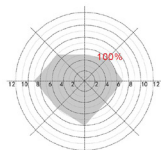

Rapid movement  
(Speed : 1 m/s)

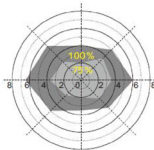

Rapid movement  
(Speed : 1 m/s)

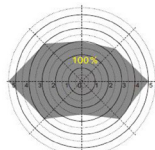

Slow movement  
(Speed: 0,3 m/s)

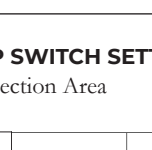

Slow movement  
(Speed : 0,3 m/s)

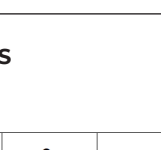

Slow movement  
(Speed : 0,3 m/s)

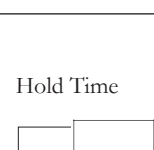

Slow movement  
(Speed: 0,3 m/s)

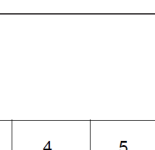

## DIP SWITCH SETTINGS

### Detection Area

		1	2	
	I	ON	ON	100%
	II	ON	-	75%
	III	-	ON	50%
	IV	-	-	10%

### Hold Time

		3	4	5	
	I	ON	ON	ON	5S
	II	-	ON	ON	30s
	III	ON	-	ON	90S
	IV	-	-	ON	3min
	V	ON	ON	-	20min
	VI	-	-	-	+∞



## Stand-By Period

		6	7	8	
	I	ON	ON	ON	0S
	II	-	ON	ON	5S
	III	ON	-	ON	5min
	IV	-	-	ON	10min
	V	ON	ON	-	30min
	VI	-	ON	-	1H
	VII	-	-	-	+∞

## Daylight Sensor

		1	2	3	4	
	I	-	-	ON	ON	2Lux
	II	-	-	-	ON	5Lux
	III	-	ON	ON	-	10Lux
	IV	-	-	ON	-	25lux
	V	-	ON	-	-	50lux
	VI	ON	-	-	-	100lux
	VII	-	-	-	-	Disable

## Stand by DIM Level

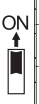
		5	6	Brightness%
	I	ON	ON	50%
	II	-	ON	30%
	III	ON	-	20%
	IV	-	-	10%

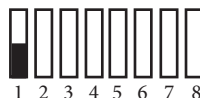

Dip switch (-) position towards number



Dip switch (ON) position away from number

## CONNECTED IN SERIES

The sensors can be connected in series to increase the detection area.

1. Move the red wire from (DIM +) to (SYNC) on both of the sensors that are connected in series.
2. Connect an extension cable with M16 connector between the sensors that are connected in series.
3. Fit the supplied M16 connector to the extension cable to connect the contacts together.

## DAYLIGHT SENSOR

The daylight sensor turns off motion detection when it is daylight. If there is continuous motion the daylight sensor is only activated when the motion stops. The daylight sensor can be set to the desired light level.

## FACTORY SETTING

Detection area: 100%, Hold time: 5s, Stand-by Period: 5s, Stand-by dim level: 10%, Daylight Sensor: Disable

## APPLICATION

This sensor is mainly for use in a closed environment. Wind, rain, and moving outdoor objects can cause false triggering, detection area needs to be closely monitored.

Please ensure that there are no moving signals around the sensor, such as fan, DC motor, sewer pipe, air outlet, etc., the sensor may generate false trigger.





**El-Björn AB**

Box 29, SE-334 21 Anderstorp, Sweden, +46 (0)371-588 100  
info@elbjorn.se, www.elbjorn.com

